

## Lineaarsed õhupumbad Alita (membraanpuhurid)

- 1.1\_ Standardsed pumbamudelid
- 1.2\_ Mudelid rõhu ja vaakumi tekitamiseks
- 1.3\_ OEM pumbaseeria



**INECO**

**Air and Vacuum  
Components**

[in-eco.co.ee](http://in-eco.co.ee)

# 1

## Lineaarsed õhupumbad Alita (membraanpuhurid)

Lineaarsed õhupumbad Alita on tõhusad suruõhuallikad. Nende kavandamisel on peetud silmas madalat mürataset ja väikest elektrienergia tarvet. Õhuvool tekitatakse ühesuunaliste (3) ventiilidega korkides paiknevate elastsete membraanide (1) vibreeriva liikumisega (2). Püsिमagneti (4), millele on membraanid kinnitatud, paneb liikuma elektromagnetiliste mähiste paari tekitatud vahelduv magnetväli (5). Kogu protsess toimub nii ilma mehaanilise hõõrdumiseta ning suure tõhususe ja väikese müraga.

### Iseloomustus

- > sujuv õhuvool
- > väike müra ja vibratsioon
- > suur tõhusus
- > väike elektrienergia tarve
- > pikk kasutusaeg
- > õlivaba
- > kompaktne ja kerge konstruktsioon
- > lihtne hooldamine
- > termokaitse
- > võimalik kasutada nii sise- kui välistingimustes
- > tõrgeteta töö nii katkestustega kui ka pideval kasutamisel
- > ohutu konstruktsioon
- > automaatne membraanide vigade tuvastamine

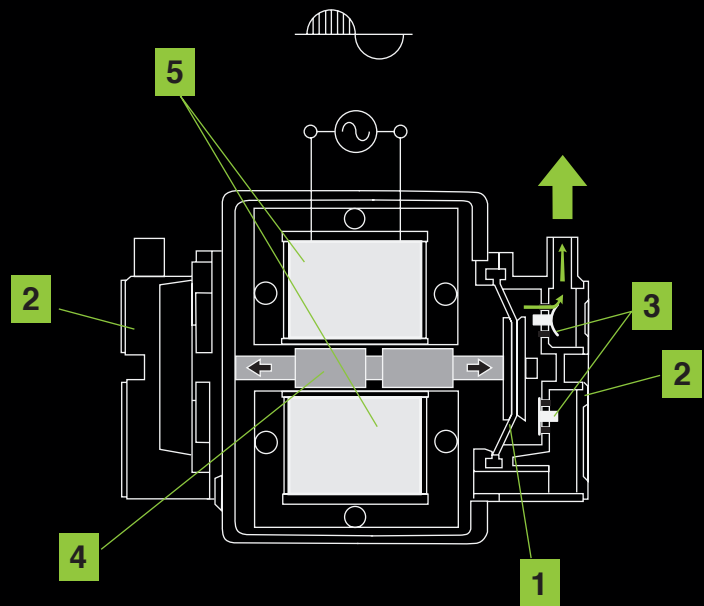

# 1

## Lineaarsed õhupumbad Alita (membraanpuhurid)

—

### 1.1

#### Standardised pumbamudelid

# 1

## Lineaarsed õhupumbad Alita (membraanpuhurid)

—

### 1.1

#### Standardised pumbamudelid

## Alita lineaarsed õhupumbad

Standardsed pumbamudelid **AL-40, AL-60, AL-80**

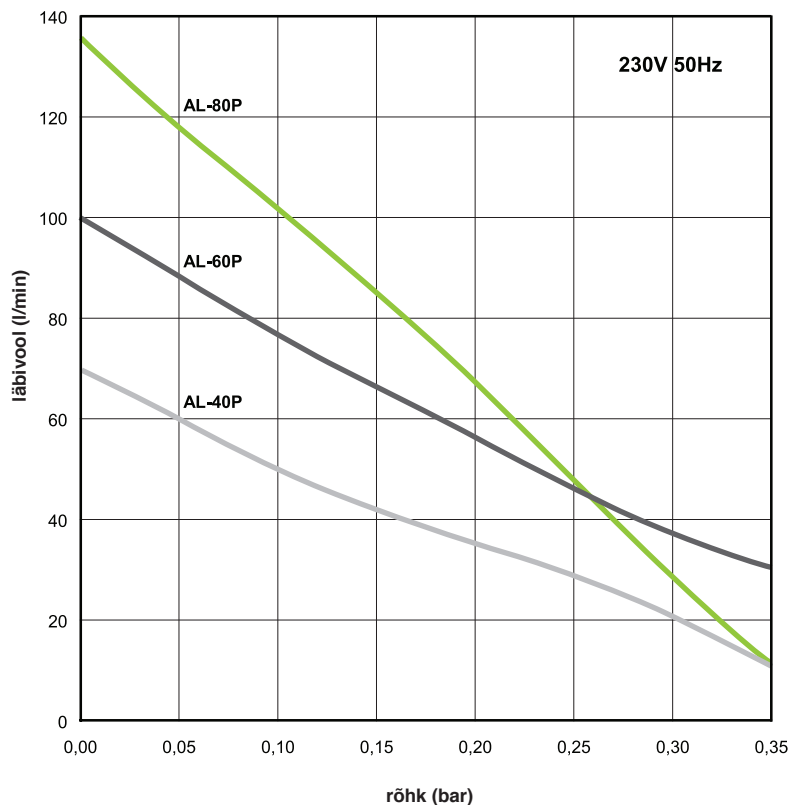

Mudel	AL-40	AL-60	AL-80
Maks Võimsus	48 W	72 W	86 W
Müratase	36 dB	38 dB	39 dB
Mass	5.6 kg	6.5 kg	6.5 kg
Väljund ø	18 mm		
Maks töö rõhk	220 mbar		
Võimsus(Maks töö rõhk)	40 W	50 W	52 W
Pinge, sagedus	230V 50Hz		
Kaitseklass IP	IP54		
Mõõtmed P x L x K	205 mm x 173 mm x 202 mm		

Toodud info põhineb nimiväärtuse testide tulemustel. Spetsifikatsioone võidakse muuta ilma sellest teatamata.

## Alita lineaarsed õhupumbad

Standardsed pumbamudelid **AL-100, AL-120, AL-150, AL-200**

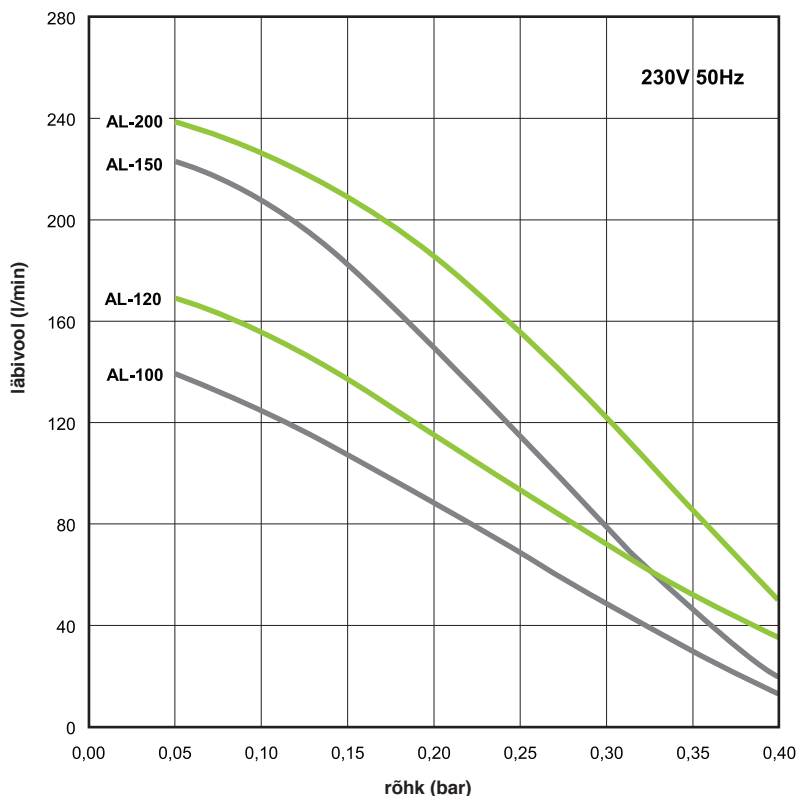

Mudel	AL-100	AL-120	AL-150	AL-200
Maks Võimsus	120 W	124 W	160 W	261 W
Müratase	41 dB	42 dB	44 dB	45 dB
Mass	8.3 kg	8.3 kg	10.1 kg	10.1 kg
Väljund ø	18 mm		26 mm	
Maks töö rõhk	260 mbar			
Võimsus(Maks töö rõhk)	78 W	97 W	110 W	125 W
Pinge, sagedus	230V 50Hz			
Kaitseklass IP	IP54			
Mõõtmed P x L x K	248 mm x 205 mm x 245 mm			

Toodud info põhineb nimiväärtuse testide tulemustel. Spetsifikatsioone võidakse muuta ilma sellest teatamata.

## Alita linearsed õhupumbad

Standardised pumbamudelid **AL-250, AL-300, AL-400**

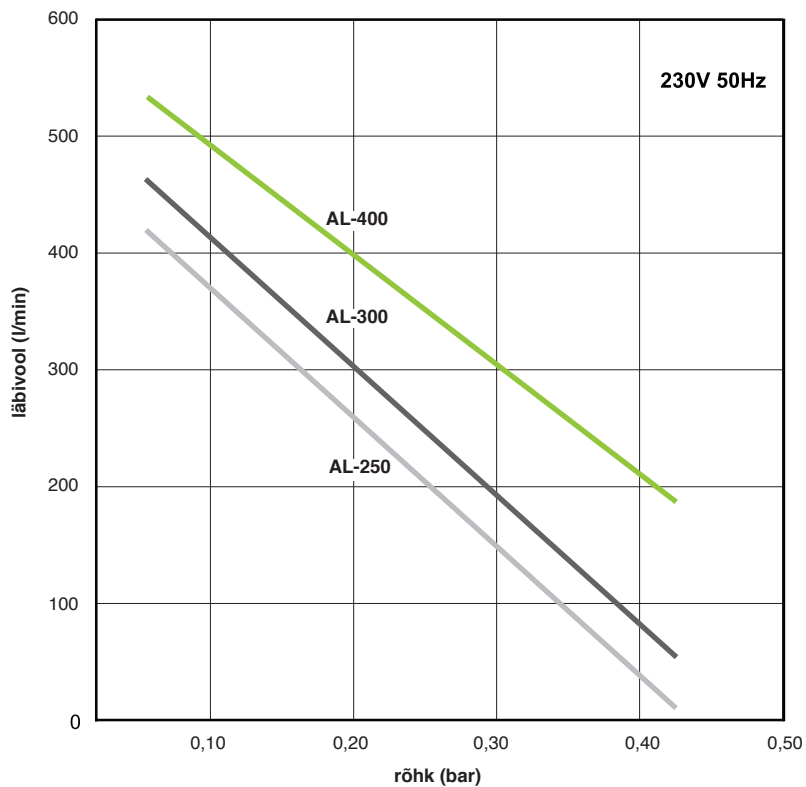

Mudel	AL-250	AL-300	AL-400
Maks Võimsus	240 W	290 W	440 W
Müratase	46 dB	47 dB	49 dB
Mass	18,8 kg	22,1 kg	22,2 kg
Väljund ø	30 mm		
Maks töö rõhk	260 mbar		
Pinge, sagedus	230V 50Hz		
Kaitseklass IP	IP54		
Mõõtmed P x L x K	420 mm x 248 mm x 262 mm		

Toodud info põhineb nimiväärtuse testide tulemustel. Spetsifikatsioone võidakse muuta ilma sellest teatamata.

# 1

## Lineaarsed õhupumbad Alita (membraanpuhurid)

—

### 1.2

## Mudelid rõhu ja vaakumi tekitamiseks



## Alita lineaarsed õhupumbad

Mudelid rõhu tekitamiseks  
**AL-6A, AL-15A**



Mudelid rõhu ja vaakumi tekitamiseks  
**AL-6SA, AL-15SA**

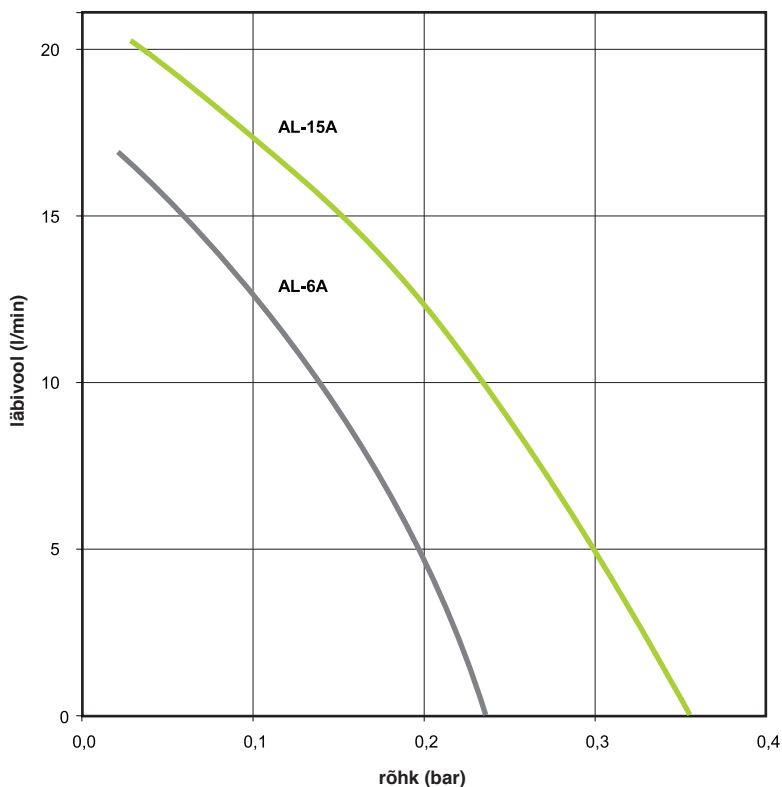

Model	AL-6A/AL-6SA	AL-15/AL-15SA
Voolutugevus	0,1 A	0,2 A
Maks Võimsus	13 W	26 W
Müratase	27 dB	29 dB
Mass	2,4 kg	2,4 kg
Maks töörõhk	100 mbar	
Mõõtmed P x L x K	150 mm x 130 mm x 111 mm	
Pinge, sagedus	230V 50Hz	
Kaitseklass IP	IP54	

Toodud info põhineb nimiväärtuse testide tulemustel. Spetsifikatsioone võidakse muuta ilma sellest teatamata.

## Alita lineaarsed õhupumbad

Modely na tlak a vákuum  
**AL-40SA, AL-60SA, AL-80SA**

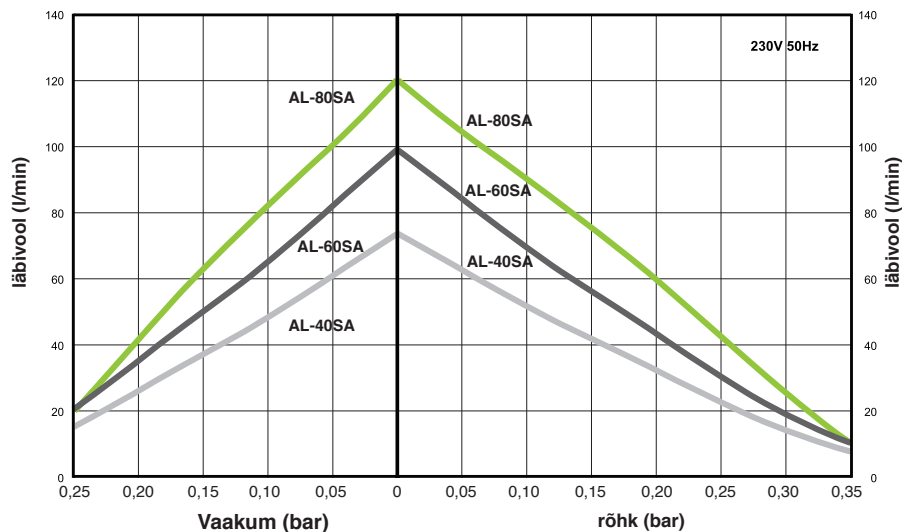

Model	AL-40SA	AL-60SA	AL-80SA
Maks Võimsus	48 W	72 W	86 W
Müratase	36 dB	38 dB	39 dB
Mass	5.6 kg	6.5 kg	6.5 kg
Väljund ø	1/4" FPT		
Maks töö rõhk	210 mbar		
Maks. töö vaakum	150 mbar		
Energiatarve (max töö rõhk)	40 W	50 W	52 W
Pinge, sagedus	230V 50Hz		
Kaitseklass IP	IP54		
Mõõtmed P x L x K	205 mm x 173 mm x 202 mm		

Toodud info põhineb nimiväärtuse testide tulemustel. Spetsifikatsioone võidakse muuta ilma sellest teatamata.

# 1

## Lineaarsed õhupumbad Alita (membraanpuhurid)

—

### 1.3 OEM Pumbaseeria

# 1

## Lineaarsed õhupumbad Alita (membraanpuhurid)

—

### 1.3 OEM Pumbaseeria

## Alita lineaarsed õhupumbad

OEM Pumbaseeria

lehekülje 1 z 2

Lisaks suurele valikule standardsetele pumbamudelitele pakume tootja originaalseadmeid – lineaarsete õhupumpade OEM seeriat, mis on mõeldud ainulaadsete rakenduste jaoks mitmesugustes tööstusharudes.

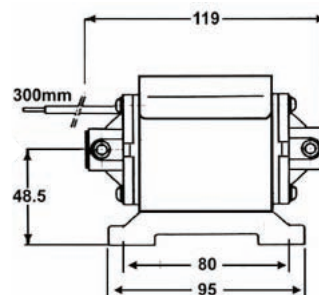
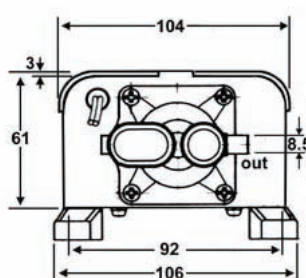
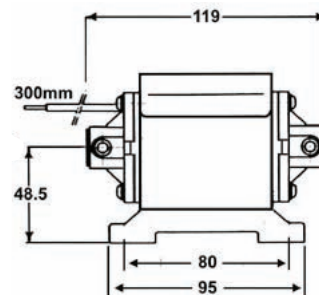
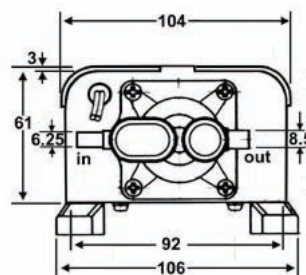
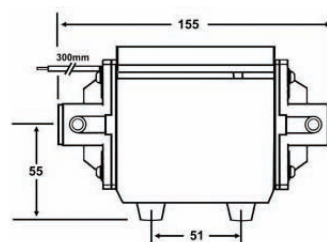
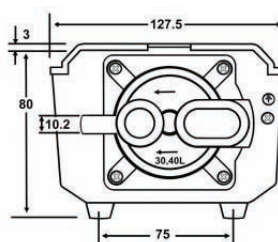
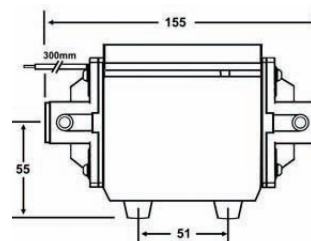
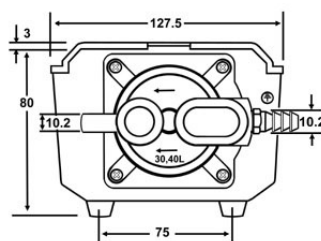
**AL-6B**  
**AL-15B**  
**AL-20B**

**AL-6SB**  
**AL-15SB**  
**AL-20SB**

**AL-30B**  
**AL-40B**  
**AL-50B**

**AL-30SB**  
**AL-40SB**  
**AL-50SB**

## Alita lineaarsed õhupumbad

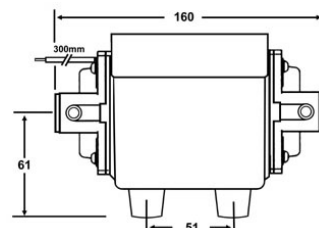
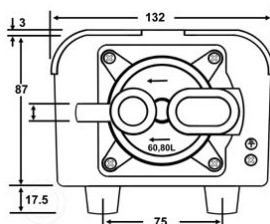
OEM Pumbaseeria

lehekülje 2 z 2

### AL-60B



### AL-60SB

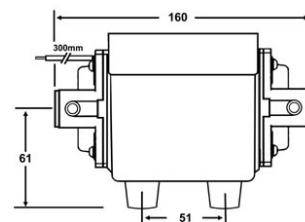
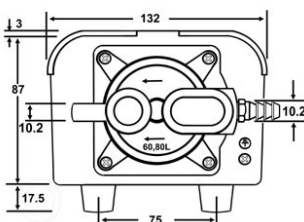

### AL-80B

### AL-100B

### AL-120B



Rõhuühendus: 15 mm (2x)  
Mõõtmed 133x175x105 mm

### AL-80SB

### AL-100SB

### AL-120SB



Rõhuühendus: 15 mm (2x)  
Vaakumühendus: 10 mm  
Mõõtmed 133x175x105 mm



**INECO**

IN-ECO, spol. s r.o.  
Radlinského 13  
034 01 Ružomberok  
Slovaki Vabariik  
T +421 44 4304662  
F +421 44 4304663  
E info@in-eco.co.ee  
www.in-eco.co.ee

26.11.2018