

Lineaarsed õhupumbad Alita (Membraanpuhurid)



- 1.1_ Standardsed pumbamudelid
- 1.2_ Mudelid rõhu ja vaakumi tekitamiseks
- 1.3_ OEM pumbaseeria



INECO[®]

**Air and Vacuum
Components**

www.in-eco.co.ee

1

Lineaarsed õhupumbad Alita (Membraanpuhurid)

Lineaarsed õhupumbad Alita on tõhusad suruõhuallikad. Nende kavandamisel on peetud silmas madalat mürataset ja väikest elektrienergia tarvet. Õhuvool tekitatakse ühesuunaliste (3) ventiilidega korkides paiknevate elastsete membraanide (1) vibreeriva liikumisega (2). Püsimagneti (4), millele on membraanid kinnitatud, paneb liikuma elektromagnetiliste mähiste paari tekitatud vahelduv magnetväli (5). Kogu protsess toimub nii ilma mehaanilise hõõrdumiseta ning suure tõhususe ja väikese müraga.

Iseloomustus:

- > sujuv õhuvool
- > väike müra ja vibratsioon
- > suur tõhusus
- > väike elektrienergia tarve
- > pikk kasutusaeg
- > Õlivaba varustus
- > kompaktne ja kerge konstruktsioon
- > lihtne hooldamine
- > termokaitse
- > võimalik kasutada nii sise- kui välistingimustes
- > tõrgeteta töö nii katkestustega kui ka pideval kasutamisel
- > ohutu konstruktsioon
- > automaatne membraanide vigade tuvastamine

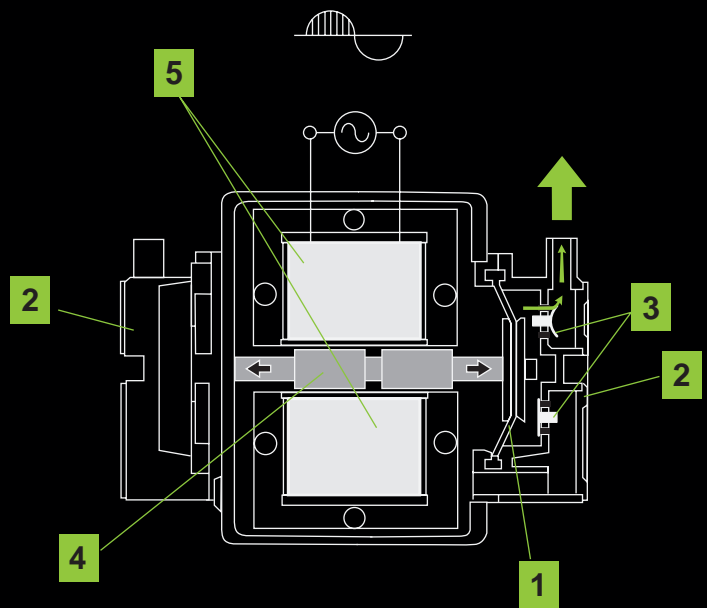

1

Lineaarsed õhupumbad Alita (Membraanpuhurid)

—

1.1

Standardised pumbamudelid

1

Lineaarsed õhupumbad Alita (Membraanpuhurid)

1.1

Standardised pumbamudelid

Alita_Lineaarsed õhupumbad

Standardised pumbamudelid **AL-40, AL-60, AL-80**

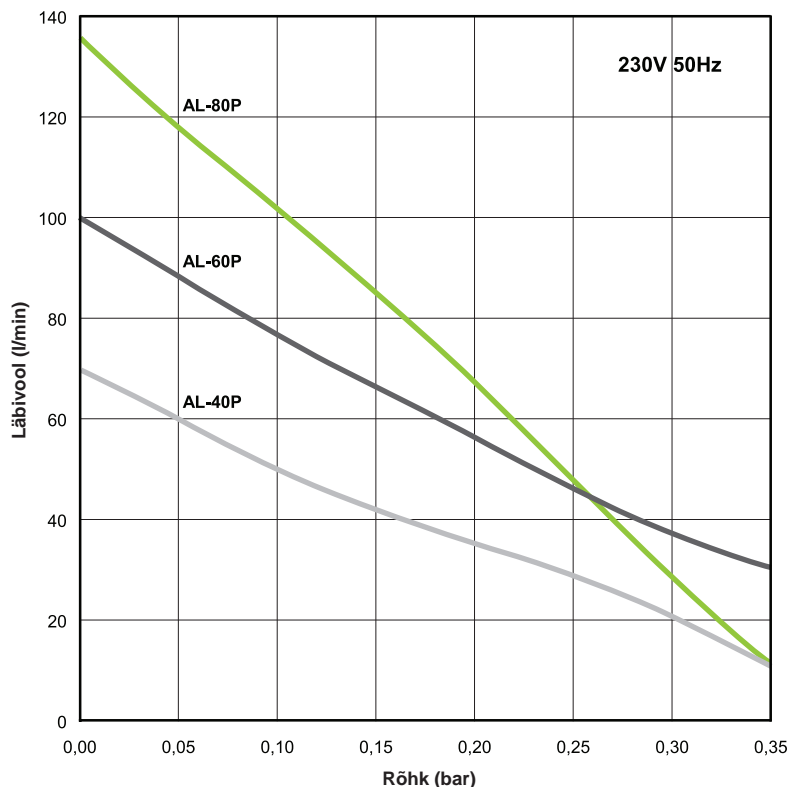

Model	AL-40	AL-60	AL-80
Maks Võimsus	48 W	72 W	86 W
Müratase	36 dB	38 dB	39 dB
Mass	5.6 kg	6.5 kg	6.5 kg
Väljund ø	18 mm		
Maks töörõhk	220 mbar		
Võimsus(Maks töörõhk)	40 W	50 W	52 W
Pinge, sagedus	230V 50Hz		
Kaitseklass IP	IP54		
Mõõtmed P x L x K	205 mm x 173 mm x 202 mm		

Toodud info põhineb nimiväärtuse testide tulemustel. Spetsifikatsioone võidakse muuta ilma sellest teatamata.

Alita_Linearsed õhupumbad

Štandardné modely **AL-100, AL-120, AL-150, AL- 200**

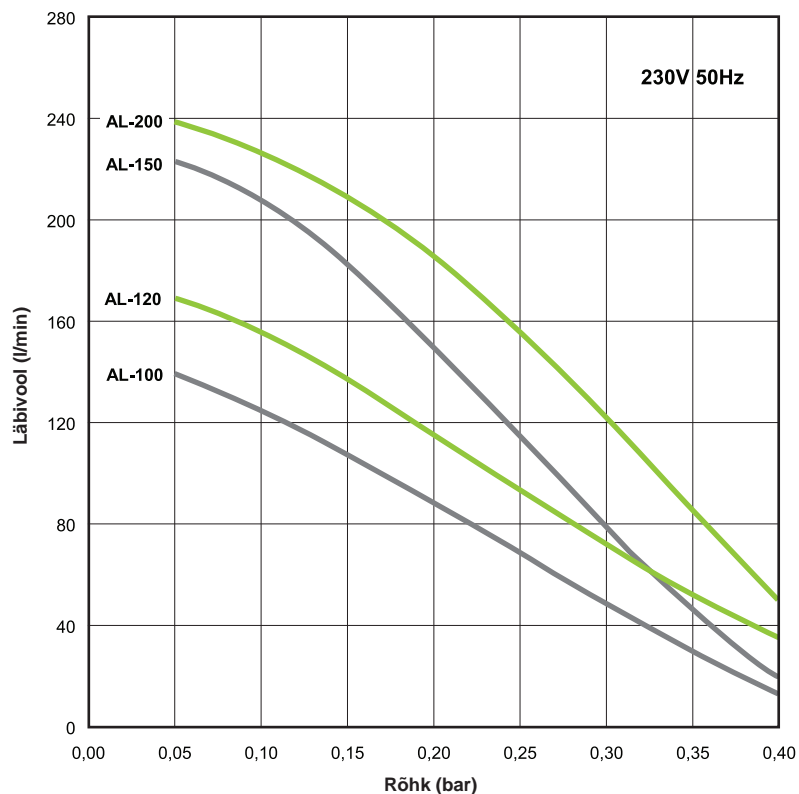

Model	AL-100	AL-120	AL-150	AL-200
Maks Võimsus	120 W	124 W	160 W	261 W
Müratase	41 dB	42 dB	44 dB	45 dB
Mass	8.3 kg	8.3 kg	10.1 kg	10.1 kg
Väljund ø	18 mm		26 mm	
Maks töö rõhk	260 mbar			
Võimsus(Maks töö rõhk)	78 W	97 W	110 W	125 W
Pinge, sagedus	230V 50Hz			
Kaitseklass IP	IP54			
Mõõtmed P x L x K	248 mm x 205 mm x 245 mm			

Toodud info põhineb nimiväärtuse testide tulemustel. Spetsifikatsioone võidakse muuta ilma sellest teatamata.

Alita_Lineaarsed õhupumbad

Standardsed pumbamudelid **AL-250, AL-300, AL-400**

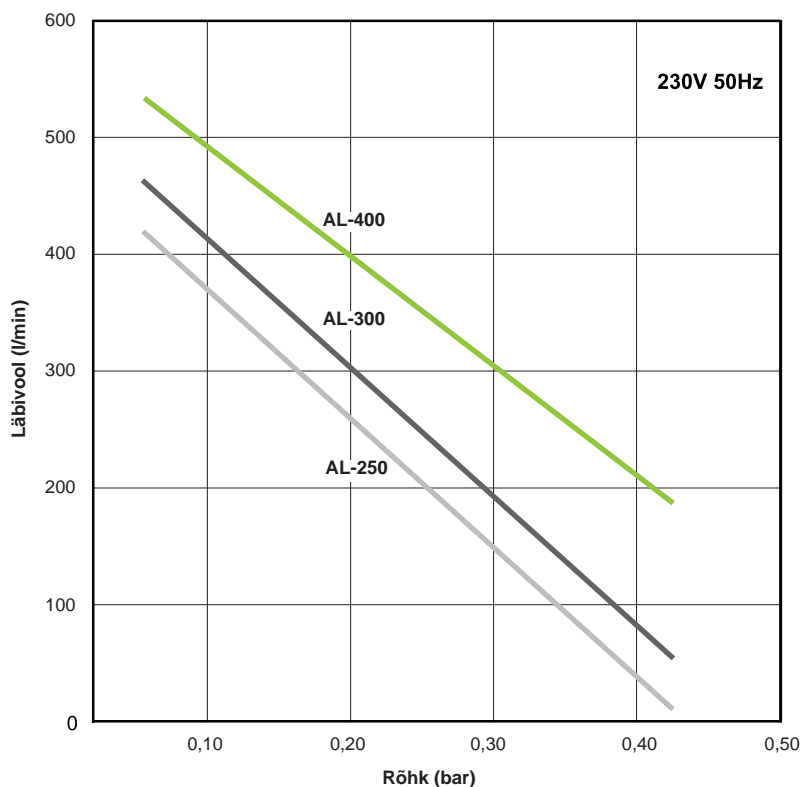

Model	AL-250	AL-300	AL-400
Maks Võimsus	240 W	290 W	440 W
Müratase	46 dB	47 dB	49 dB
Mass	18,8 kg	22,1 kg	22,2 kg
Väljund ø	30 mm		
Maks töö rõhk	260 mbar		
Pinge, sagedus	230V 50Hz		
Kaitseklass IP	IP54		
Mõõtmed P x L x K	420 mm x 248 mm x 262 mm		

Toodud info põhineb nimiväärtuse testide tulemustel. Spetsifikatsioone võidakse muuta ilma sellest teatamata.

1

Lineaarsed õhupumbad Alita (Membraanpuhurid)

—

1.2

Mudelid rõhu ja vaakumi tekitamiseks

Alita_Lineaarsed õhupumbad

Mudelid rõhu tekitamiseks
AL-6A, AL-15A



Mudelid rõhu ja vaakumi tekitamiseks
AL-6SA, AL-15SA, AL-30MSA

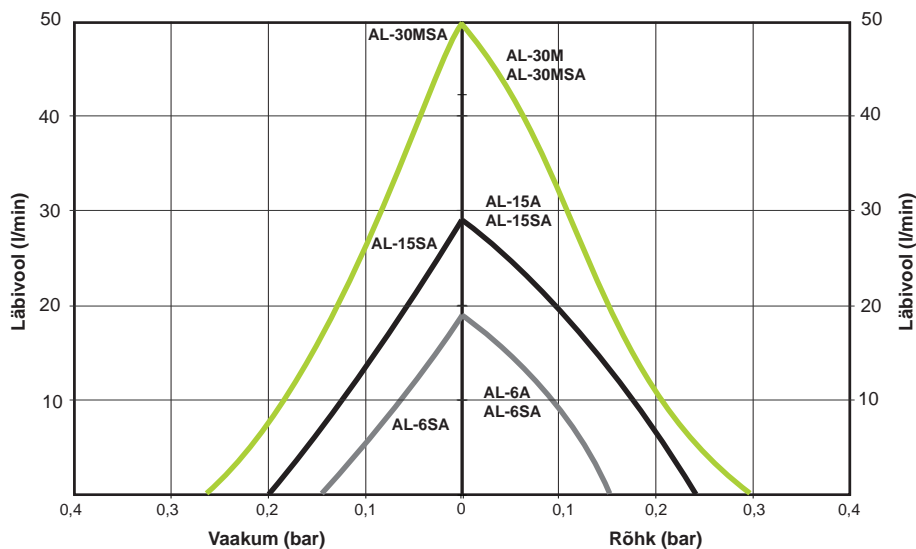

Model	AL-6A/ AL-6SA	AL-15A/ AL-15SA	AL-30M/ AL-30MSA
Vool	0,1 A	0,2 A	0,25 A
Võimsus	13 W	26 W	35 W
Müratase	27 dB	29 dB	35 dB
Mass	2,4 kg	2,4 kg	3,7 kg
Maks töö rõhk	100 mbar		200 mbar
Mõõtmed P x L x K	150 mm x 130 mm x 111 mm		
Pinge, sagedus	230V 50Hz		
Kaitseklass IP	IP54		

Toodud info põhineb nimiväärtuse testide tulemustel. Spetsifikatsioone võidakse muuta ilma sellest teatamata.

Alita_Lineaarsed õhupumbad

Mudelid rõhu ja vaakumi tekitamiseks
AL-40SA, AL-60SA, AL-80SA

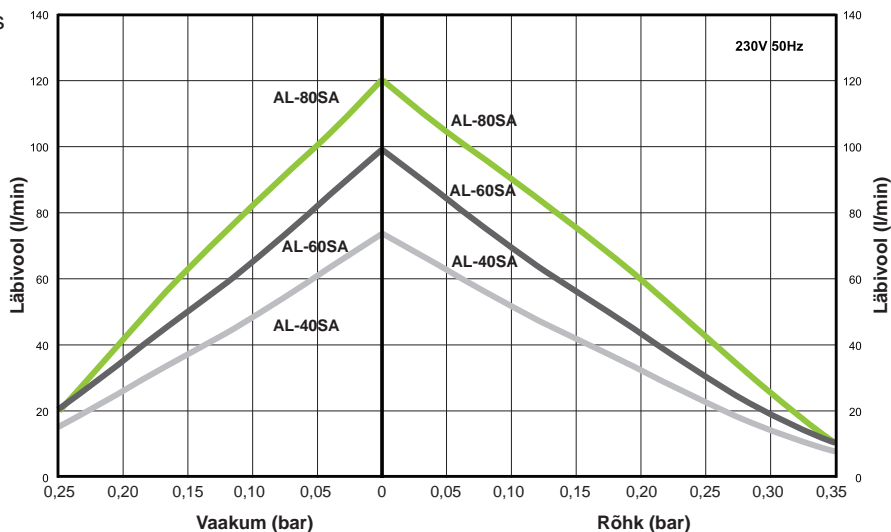

Model	AL-40SA	AL-60SA	AL-80SA
Maks Võimsus	48 W	72 W	86 W
Müratase	36 dB	38 dB	39 dB
Mass	5.6 kg	6.5 kg	6.5 kg
Väljund ø	1/4" FPT		
Maks töö rõhk	210 mbar		
Maks. töö vaakum	150 mbar		
Võimsus(Maks töö rõhk)	40 W	50 W	52 W
Pinge, sagedus	230V 50Hz		
Kaitseklass IP	IP54		
Mõõtmed P x L x K	205 mm x 173 mm x 202 mm		

Toodud info põhineb nimiväärtuse testide tulemustel. Spetsifikatsioone võidakse muuta ilma sellest teatamata.

1

Lineaarsed õhupumbad Alita (Membraanpuhurid)

—

1.3 OEM pumbaseeria

1

Lineaarsed õhupumbad Alita (Membraanpuhurid)

—

1.3 OEM pumbaseeria

Alita_Linearsed õhupumbad

OEM pumbaseeria

Lisaks suurele valikule standardsetele pumbamudelitele pakume tootja originaalseadmeid – lineaarsete õhupumpade OEM seeriat, mis on mõeldud ainulaadsete rakenduste jaoks mitmesugustes tööstusharudes.

AL-6B
AL-15B
AL-20B

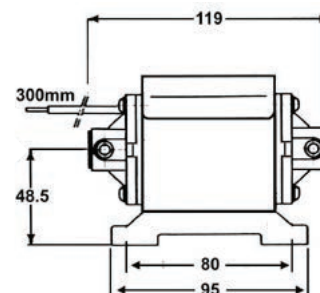
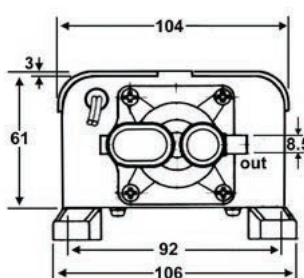

AL-6SB
AL-15SB
AL-20SB

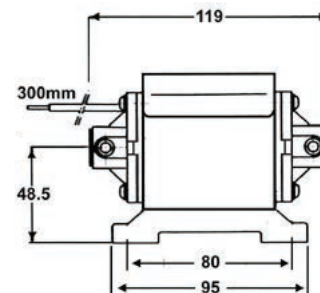
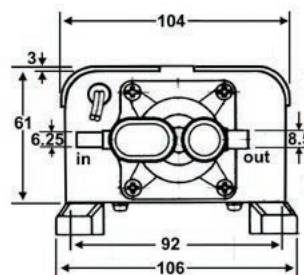

AL-30B
AL-40B
AL-50B

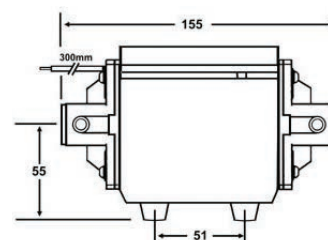
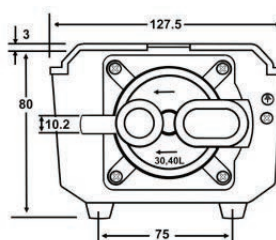

AL-30SB
AL-40SB
AL-50SB

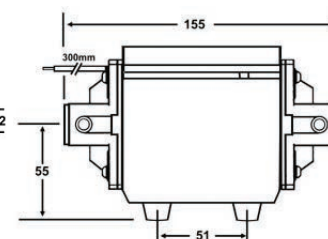
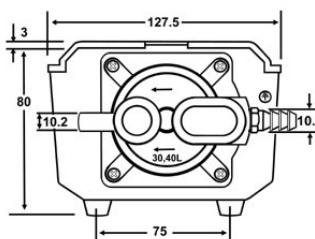

Alita_Linearsed õhupumbad

OEM pumbaseeria

AL-60B

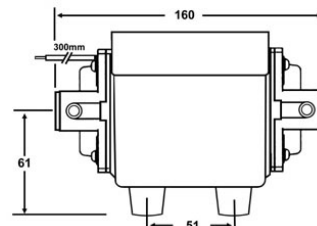
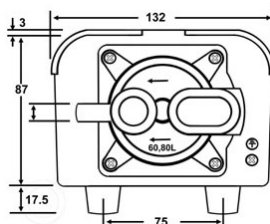

AL-60SB

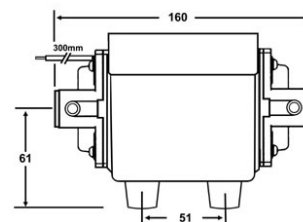
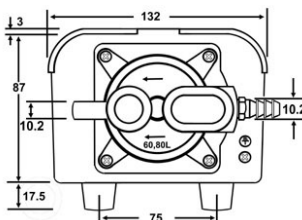

AL-80B

AL-100B



Rõhuühendus: 15 mm (2x)
Mõõtmed: 133x175x105 mm

AL-80SB

AL-100SB



Rõhuühendus: 15 mm (2x)
Vaakumühendus: 10 mm
Mõõtmed: 133x175x105 mm

INECO[®]

IN-ECO, spol. s r.o.
Radlinského 13
034 01 Ružomberok
Slovak Republic
T +421 44 4304662
E info@in-eco.eu
www.in-eco.co.ee

1.6.2022